

Panasonic

DVCPRO HD

Digital HD Video Cassette Recorder

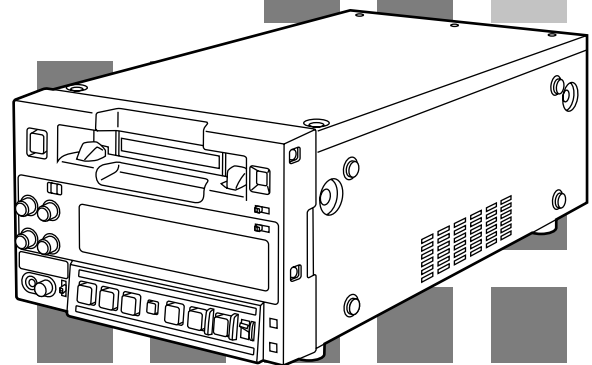

AJ-HD130 DCP

Operating Instructions



IMPORTANT

“Unauthorized recording of copyrighted television programs, video tapes and other materials may infringe the right of copyright owners and be contrary to copyright laws.”

	CAUTION RISK OF ELECTRIC SHOCK DO NOT OPEN	
CAUTION: TO REDUCE THE RISK OF ELECTRIC SHOCK, DO NOT REMOVE COVER (OR BACK). NO USER SERVICEABLE PARTS INSIDE. REFER TO SERVICING TO QUALIFIED SERVICE PERSONNEL.		



The lightning flash with arrowhead symbol, within an equilateral triangle, is intended to alert the user to the presence of uninsulated “dangerous voltage” within the product’s enclosure that may be of sufficient magnitude to constitute a risk of electric shock to persons.



The exclamation point within an equilateral triangle is intended to alert the user to the presence of important operating and maintenance (service) instructions in the literature accompanying the appliance.

■ THIS APPARATUS MUST BE EARTHED

To ensure safe operation the three-pin plug must be inserted only into a standard three-pin power point which is effectively earthed through the normal household wiring.

Extension cords used with the equipment must be three-core and be correctly wired to provide connection to earth. Wrongly wired extension cords are a major cause of fatalities.

The fact that the equipment operates satisfactorily does not imply that the power point is earthed and that the installation is completely safe. For your safety, if in any doubt about the effective earthing of the power point, consult a qualified electrician.

WARNING:

TO REDUCE THE RISK OF FIRE OR SHOCK HAZARD, DO NOT EXPOSE THIS EQUIPMENT TO RAIN OR MOISTURE.

CAUTION:

TO REDUCE THE RISK OF FIRE OR SHOCK HAZARD AND ANNOYING INTERFERENCE, USE THE RECOMMENDED ACCESSORIES ONLY.

FCC Note:

This device complies with Part 15 of the FCC Rules. To assure continued compliance follow the attached installation instructions and do not make any unauthorized modifications.

This equipment has been tested and found to comply with the limits for a class A digital device, pursuant to Part 15 of the FCC Rules. These limits are designed to provide reasonable protection against harmful interference when the equipment is operated in a commercial environment. This equipment generates, uses, and can radiate radio frequency energy and, if not installed and used in accordance with the instruction manual, may cause harmful interference to radio communications. Operation of this equipment in a residential area is likely to cause harmful interference in which case the user will be required to correct the interference at his own expense.

CAUTION:

Do not install or place this unit in a bookcase, built-in cabinet or in another confined space in order to keep well ventilated condition. Ensure that curtains and any other materials do not obstruct the ventilation condition to prevent risk of electric shock or fire hazard due to overheating.

 indicates safety information.

- Do not insert fingers or any objects into the video cassette holder.
- Avoid operating or leaving the unit near strong magnetic fields. Be especially careful of large audio speakers.
- Avoid operating or storing the unit in an excessively hot, cold, or damp environment as this may result in damage both to the recorder and to the tape.
- Do not spray any cleaner or wax directly on the unit.
- If the unit is not going to be used for a length of time, protect it from dirt and dust.
- Do not leave a cassette in the recorder when not in use.
- Do not block the ventilation slots of the unit.
- Use this unit horizontally and do not place anything on the top panel.
- Cassette tape can be used only for one-side, one direction recording. Two-way or two-track recordings cannot be made.
- Cassette tape can be used for either Color or Black & White recording.
- Do not attempt to disassemble the recorder. There are no user serviceable parts inside.
- If any liquid spills inside the recorder, have the recorder examined for possible damage.
- Refer any needed servicing to authorized service personnel.

Contents

Introduction	4	Setup Menus	24
Features	4	SYSTEM	24
Parts and Their Functions	5	BASIC	25
Front panel	5	OPERATION	27
Rear panel	10	INTERFACE	29
Operation	12	TAPE PROTECT	29
Turning on the power and inserting the cassette	12	TIME CODE	30
STOP mode	12	VIDEO	32
Recording	13	AUDIO	33
Rec pause/recording (frame-to-frame continuity)	13	MENU	35
Playback	14	Error Messages	36
Cue (fast forward playback)/review (reverse playback)	14	Emergency Eject	37
Still-picture playback	14	Video Head Cleaning	38
Linear 0.3× speed playback	15	Condensation	38
Variable-speed playback	15	Maintenance	38
Repeat playback	16	Specifications	39
Time Code & User's Bit	17		
Time code	17		
User's bit	17		
Setting the time code	17		
Setting the user's bit	18		
Time code/user's bit playback	18		
Superimposed Screens	19		
Setup (Initial Settings)	20		
How to perform settings using the on-screen menu	20		
How to return to the factory settings	20		
How to set the user defaults	21		
How to load the user defaults	22		
How to protect the menus	22		
How to release the menu protection	23		
How to display the DIAG menu	23		

Introduction

This DVCPRO HD format HD digital VTR uses 1/4" wide small cassette tapes to record and play back interlace HD signals (1080i/59.94 Hz) and progressive HD signals (720p/59.94 Hz).

It contains built-in down-converter outputs as a standard feature to provide interfacing with existing SD (standard definition) systems by means of HD-SD conversion.

The deterioration in the picture and sound quality which accompanies dubbing is significantly reduced by this high picture quality VTR which incorporates high-efficiency digital compression technology.

The VTR has a compact and lightweight design which enables it to be carried around or installed in a rack with ease.

The user performs the equipment settings interactively while viewing the on-screen menus on the TV monitor.

Features

Compact size and light weight

The VTR has a width of 8 7/16" (214 mm), a height of 5 1/4" (132 mm) and a depth of 16 15/16" (430 mm), and it weighs 18.04 lb (8.2 kg). It comes with grips which make it easy and convenient to carry it.

Efficient installation in a rack

The width of the VTR is half the standard 19" dimension, and its height is equivalent to 3U. This makes its installation in a rack twice as efficient as in the past for greater economy.

Up to 46 minutes of recording

The VTR uses only 1/4" wide L-size cassette tapes (max. 46 minutes).

<Note>

Do not use tapes other than DVCPRO HD L-size cassettes (max. 46 minutes).

High picture quality

The VTR achieves a high picture quality by means of 4:2:2 HD component signal recording conducted at a rate which is four times faster (100 Mbps) than the existing DVCPRO format.

Switching between 1080i and 720p systems

By switching to the matching video signal input system (1080i/59.94 Hz or 720p/59.94 Hz) in the setup menu settings, the VTR can record and play back signals in either signal system.

SD down-converter

The VTR comes with a built-in SD down-converter as a standard feature. This enables SD SDI signals or analog composite signals to be output at the same time as HD SDI signals are output, and this makes it possible to view the signals on the SD monitor.

AD/DC operation

The VTR operates on both AC 120 V and DC 12 V power.

Frame-to-frame continuity function

By using the REC button and PAUSE button in combination, the auto back function is activated so that the images are joined together smoothly, without any breaks.

On-screen menu settings

The highly individualized function settings can be performed on-screen.

Time code

The VTR is equipped with a built-in TCG (time code generator)/TCR (time code reader). An external time code can also be input, thereby enabling regeneration to the external time code.

Multi-functional interfaces

● Serial digital input/output

The VTR has HD component serial interface input/output facilities so that the HD component video signals and digital audio signals of 8 channels can be interfaced using a single BNC connector. (SMPTE 292M/296M/299M)

It also contains a built-in SD down-converter as a standard feature so that SD component serial signals can also be output.

(SMPTE 259M-C, 272M-A)

● Analog video output

Also provided as a standard feature is a built-in analog composite down-converter to enable monitoring on an SD monitor.

● 9-pin remote control connector

This connector enables operations to be performed from the external remote controller (AJ-A95, optional accessory).

Parts and Their Functions

Front panel

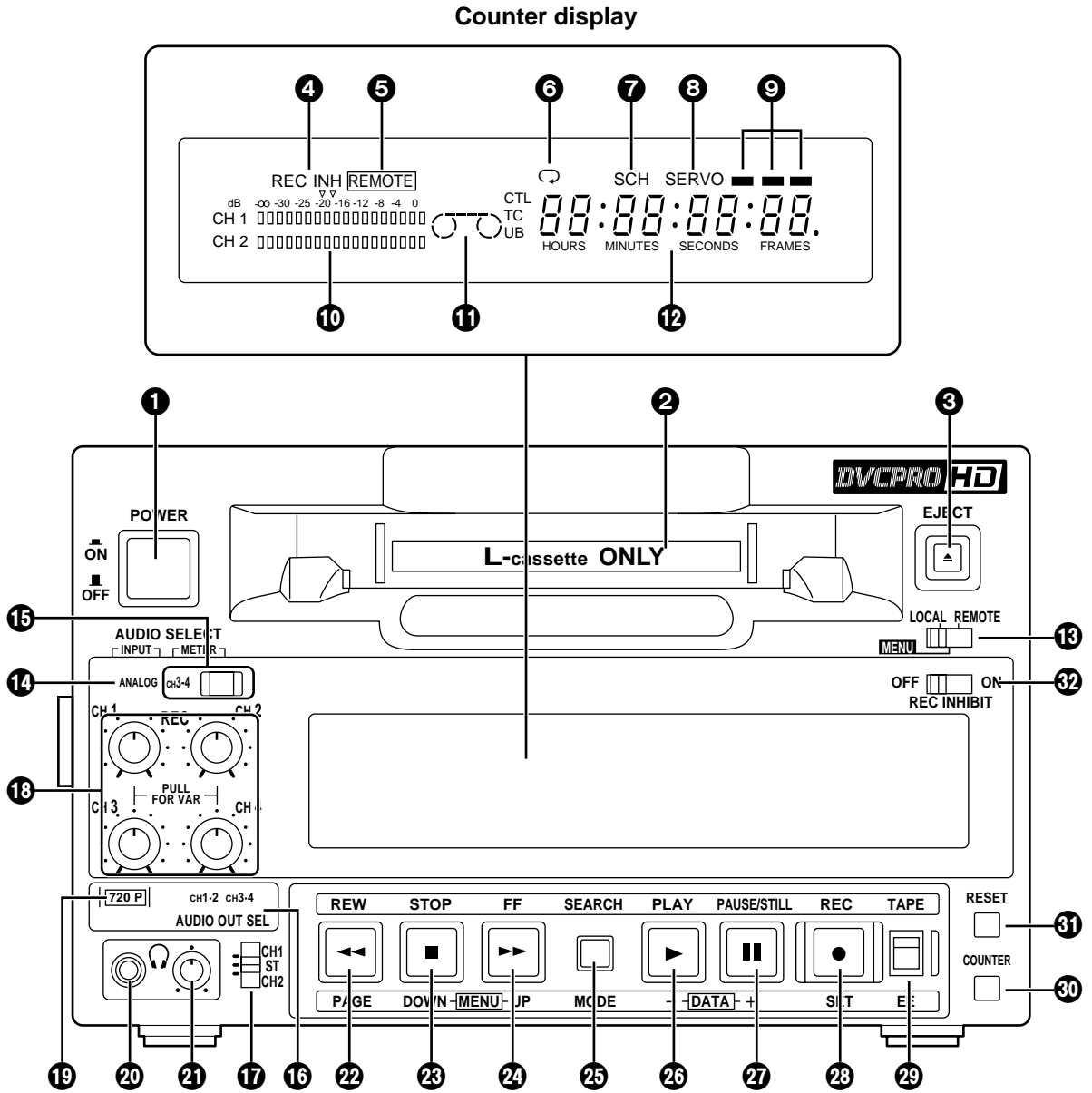

Parts and Their Functions

Front panel

① POWER switch

② Cassette loading slot

Align the cassette with the center of the loading slot, and push it gently inside. The cassette is loaded automatically.

<Note>

Do not insert tapes other than DVCPRO HD L-size cassettes.

③ EJECT button

Press this to unload the tape which is then ejected automatically several seconds later.

The display is reset when the CTL display is shown on the counter display.

④ REC and REC INH lamps

REC : This lights while recording is in progress.

REC INH : This lights when the cassette is in the accidental erasure prevention status.

It also lights when the REC INHIBIT switch ⑫ is at the ON position. Nothing can be recorded when this lamp is lit.

⑤ REMOTE lamp

This lights when the LOCAL/MENU/REMOTE switch ⑬ is set to the REMOTE position.

⑥ REPEAT lamp

This lights during repeat playback.

<Note>

The lamp flashes and repeat playback is not performed if the counter display mode which was set using setup menu item No.161 (BGN PRESET) or No.162 (END PRESET) and the counter display mode in which the repeat playback is to be performed do not match.

⑦ SCH lamp

This lights when the subcarrier phase of the SD signals which have been supplied to the HD/SD REF VIDEO IN connectors is within the specified range.

⑧ SERVO lamp

This lights when the drum servo and capstan servo lock.

⑨ Channel condition lamps

These light in accordance with the error rate status. (Green → blue → red)

Green : This lights when the error rates for the video and audio playback signals are satisfactory.

Blue : This lights when the error rate for either the video or audio playback signals has deteriorated. The playback pictures remain normal even when the lamp lights.

Red : This lights when either the video or audio playback signals have been corrected or interpolated.

⑩ Level meter

This indicates the audio signal levels.

The input level of the audio signals is displayed during recording and when the E-E status is selected; their output level is displayed during playback.

⑪ Cassette insertion/tape travel display lamp

This lights when a cassette has been inserted into the VTR.

 : When a tape has been inserted and the STANDBY ON mode is established.

 : When a tape has been inserted and the STANDBY OFF (half loading) mode is established.

 : While the tape is traveling, the segment display moves as the tape runs.

 : When the fan has stopped, the "○" at the stopped side flashes.

⑫ Counter display

The TC or CTL count, user's bit, remaining tape and total tape length as well as messages and other on-screen information are indicated on this display.

While the unit is running on DC power, the display flashes to signal a warning when the voltage has dropped.

The power is automatically turned off when the voltage drops to 10.6 V or so.

CTL, TC and UB lamps

The corresponding lamp flashes when the TC or UB information cannot be read during playback.

It lights when the information can be read correctly.

Parts and Their Functions

Front panel

13 LOCAL/MENU/REMOTE switch

This is set when performing menu settings or controlling the VTR from an external device.

LOCAL : When the VTR is to be controlled using the controls on its operation panel.

MENU : When on-screen menu items are to be set.

REMOTE: When VTR is to be controlled using an external remote controller (AJ-A95).

14 ANALOG lamp

This lights when "ANALOG" has been selected as the setup menu item No.700 setting for the audio input signals.

<Note>

When analog signals are input, they are recorded on the tape's audio tracks listed below depending on the channel to which they are input.

CH1 input ➔ CH1 and CH5 tracks

CH2 input ➔ CH2 and CH6 tracks

CH3 input ➔ CH3 and CH7 tracks

CH4 input ➔ CH4 and CH8 tracks

15 METER button and lamp (CH3•4)

Each time the METER button is pressed, what is displayed on the level meter is switched from the CH1/CH2 levels to the CH3/CH4 levels or vice versa.

The CH3•4 lamp goes off when the CH1/CH2 levels are displayed.

<Note>

The METER button works when "LINE" has been selected as the setup menu item No.780 setting for the analog audio output connectors.

16 Audio output lamps (CH1•2, CH3•4)

These lamps are used to indicate the audio channels whose signals are being output.

17 Audio monitor selector switch

This is used to select the audio monitor output or headphone output channel.

Reference: Audio output combinations using setup menu items and front panel switches

Setup menu item			Front panel				Rear panel AUDIO OUT connectors				
No.780 AUD OUT SEL	No.770 MONITOR MIX	No.771 H.PHONE MIX	Audio monitor selector switch 17	Audio output lamps 16	METER lamp 15	Headphone output	CH1	CH2	CH3/L	CH4/R	
LINE	—	—	CH1	CH1•2 CH3•4	Off	L=R (CH1)	CH1	CH2	CH3	CH4	
		STEREO	CH3•4		L=R (CH3)						
			Off		L=CH1/R=CH2						
			CH3•4		L=CH3/R=CH4						
			Off		L=R (CH1+2)						
		CH1+2	CH3•4		L=R (CH3+4)						
—	CH2	Off	L=R (CH2)								
CH1/2	—	—	CH1	CH1•2	Off	L=R (CH1)	CH1	CH2	L=CH1	R=CH1	
		STEREO	CH1+2			L=CH1/R=CH2			L=CH1	R=CH2	
			STEREO			L=R (CH1+2)			L=CH1/R=CH2	L=CH1+2	R=CH1+2
			CH1+2			L=CH1/R=CH2			L=R (CH1+2)	L=CH2	R=CH2
			—			CH2			L=R (CH2)	L=CH2	R=CH2
		CH3/4	—			—			CH1	CH3•4	CH3•4
STEREO	CH1+2			L=CH3/R=CH4	L=CH3	R=CH4					
	STEREO			L=R (CH3+4)	L=CH3/R=CH4	L=CH3+4	R=CH3+4				
	CH1+2			L=CH3/R=CH4	L=R (CH3+4)	L=CH4	R=CH4				
	—			CH2	L=R (CH4)	L=CH4	R=CH4				

Parts and Their Functions

Front panel

18 Analog audio signal recording level controls

These are used to adjust the recording levels of the CH1, CH2, CH3 and C4 analog audio signals.

These are pull-to-adjust controls: they can be adjusted at their pulled-up positions. When they are at their pushed-down positions, the signals are recorded at their initial levels.

<Note>

These controls cannot be used to adjust the levels of the HD digital component audio signals.

19 720p lamp

This lights when the 720p/59.94 Hz system has been selected or its signals are being played back.

20 Headphone jack

When stereo headphones are connected to this jack, the sound being recording or played back can be monitored by headphones.

21 Volume control

This is used to control the volume of sound heard through the headphones.

22 REW button

When this is pressed, the tape is rewind. When the TAPE/EE switch 29 is set to TAPE, the playback images can be monitored.

When the button is pressed in a search mode (search still, FWD search, FWD search still or REV search still), the search is conducted in the reverse direction (REV search). The tape is reviewed at the speed set by setup menu item No.150. (See page 14)

When the button is pressed in a slow mode (slow still, FWD slow or FWD slow still), the tape is played back at the REV linear 0.3× speed. (See page 15)

23 STOP button

When this is pressed, the tape stops traveling, and still pictures can be monitored if the TAPE/EE switch 29 has been set to TAPE.

The drum continues to rotate even in the stop mode, and the tape remains wrapped tightly around the drum.

When the stop mode continues longer than the allotted time, the VTR is automatically set to the standby OFF (half loading) mode in order to protect the tape.

The stop mode is established immediately after a cassette is inserted into the VTR.

With still pictures, noise may appear on the monitor: this is normal and not indicative of a problem.

24 FF button

When this is pressed, the tape is fast forwarded. When the TAPE/EE switch 29 is set to TAPE, the playback images can be monitored.

When the button is pressed in a search mode (search still, REV search, REV search still or FWD search still), the search is conducted in the forward direction (FWD search). The tape is cued at the speed set by setup menu item No.150. (See page 14)

When the button is pressed in a slow mode (slow still, REV slow or REV slow still), the tape is played back at the FWD linear 0.3× speed. (See page 15)

25 SEARCH button

When this is pressed, the VTR is set to the search mode or slow mode. (See pages 14 and 15)

26 PLAY button

When this is pressed, playback is started. When it is pressed together with the REC button, recording is started.

27 PAUSE/STILL button

When this is pressed during recording, the recording is temporarily stopped; when it is pressed again, the recording is resumed.

When it is pressed during playback, the VTR is set to the still picture mode; when it is pressed again, playback is resumed.

When it is pressed during a FWD or REV search, the search is temporarily stopped (FWD or REV search still); when it is pressed again, the FWD or REV search is resumed.

When it is pressed during a FWD or REV slow operation, the operation is temporarily stopped (FWD or REV slow still); when it is pressed again, the FWD or REV slow operation is resumed.

A "FWD or REV slow" operation denotes linear 0.3× speed playback.

When the tape is temporarily stopped, noise may appear on the monitor: this is normal and not indicative of a problem. (See page 15)

28 REC button

When this is pressed together with the PLAY button, recording is started. When it is pressed while the tape is stopped or being ejected, the input video signals or audio signals can be checked even if the TAPE/EE switch is at the TAPE position.

The value of the time code generator can also be checked. (REC CHECK mode)

When the STOP button or any other function button is pressed, the REC CHECK mode will be released.

Parts and Their Functions

Front panel

29 TAPE/EE switch

This is used to select the signals to be output during stop, fast forwarding or rewinding.

TAPE : The signals played back from the tape are output.

EE : The HD SDI signals are output as the video signals, and the signals selected by setup menu item No.700 are output as the audio signals.

<Note>

While the switch setting is being changed, the picture and sound may be disturbed.

30 COUNTER button

This is used to select what appears on the counter display. Each time it is pressed, what is to appear on the display changes in the following sequence:

CTL → TC → UB → r → CTL.

CTL: The tape timer (control signal) is displayed.

TC : The time code is displayed.

UB : The user's bit is displayed.

r : The remaining tape and total tape length are displayed in minute increments.

Example: [r30-46]

Remaining tape: 30 minutes; total tape length: 46 minutes

31 RESET button

When this is pressed in the CTL mode, the counter display is set to 0 (reset).

32 REC INHIBIT switch

This is used to permit or inhibit recording on the cassette tape.

ON : Recording on the cassette tape is inhibited. The REC INHIBIT lamp on the display lights.

OFF: Recording on the cassette tape is permitted provided that the cassette's accidental erasure prevention tab is set to the recording enable status.

Parts and Their Functions

Rear panel

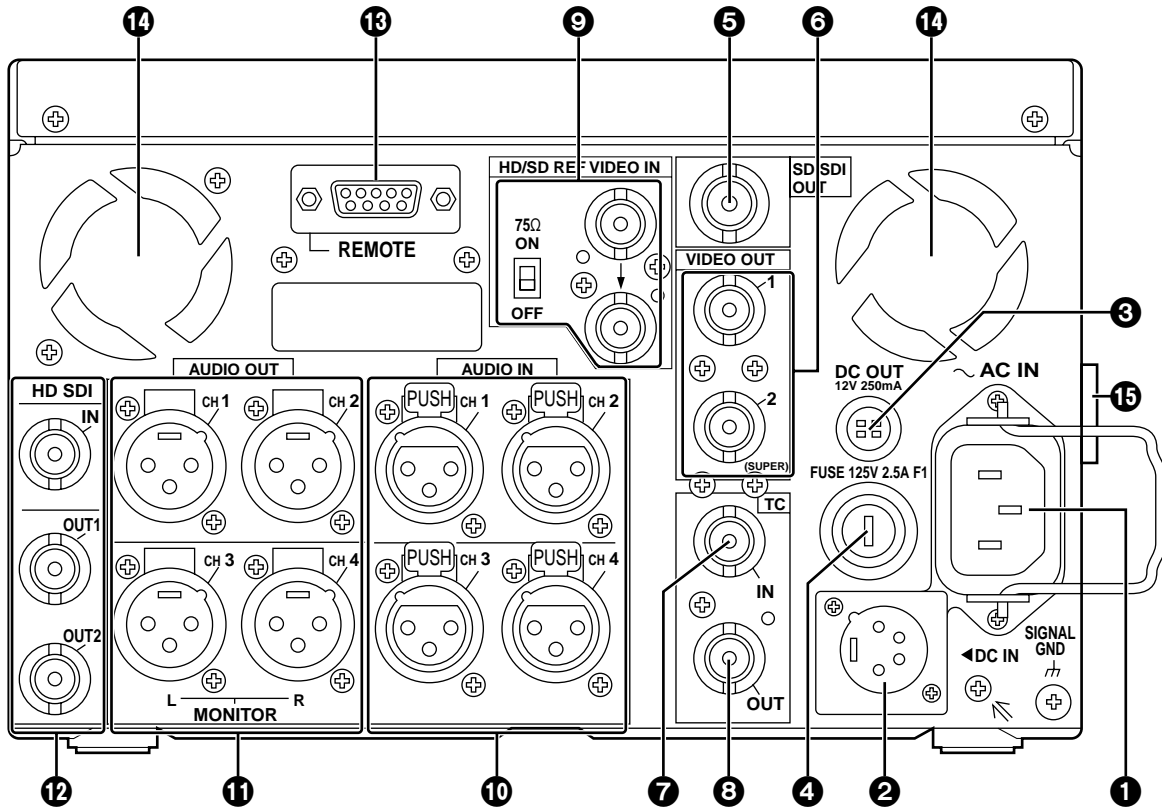

1 AC IN socket

The AC power supply is connected to this socket using the accessory power cord. AC power takes priority if both AC power and DC power have been connected.

3 DC OUT socket

This is the DC 12 V output socket. Power is supplied from here to the external remote controller (AJ-A95). The DC power cable is packed with the AJ-A95.

2 DC IN socket

This is the input socket of the DC 12 V power supply. Use the optional AC adapter (AJ-B75 or AJ-B95).

The VTR's power is automatically turned off when the voltage drops to 10.6 V or so. It may take some time for the voltage level to be restored even after the supply voltage has recovered.

AC power takes priority if both AC power and DC power have been connected.



Pin No.	Signal
1	Ground
2	—
3	—
4	+12 V

4 Fuse holder

This houses a 2.5 A fuse.

5 SD SDI OUT connector

This is the down-conversion output connector for the digital component audio and video signals complying with the SMPTE 259M-C or 272M-A standard.

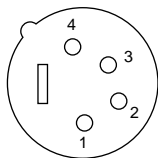

Pin No.	Signal
1	Ground
2	—
3	—
4	+12 V

Parts and Their Functions

Rear panel

⑥ VIDEO OUT (1, 2) connectors

These are the down-conversion output connectors for the analog composite video signals.

Video signals with embedded superimposed text can be output from the VIDEO OUT2 connector.

Superimposed text embedding can be selected using setup menu item No.005.

⑦ TC IN connector

This is used for recording the external time code onto the tape.

⑧ TC OUT connector

During playback, the playback time code is output from this connector; during recording, the time code generated by the internal time code generator is output.

⑨ HD/SD REF VIDEO IN connectors and 75 Ω termination switch

These are the input connectors for the HD/SD reference video signals. For termination, set the switch to ON.

<Notes>

- Input a tri-level sync signal with both positive and negative polarities when using these connectors for the HD reference. Input a signal that matches the input signals or tape format.
- Input a composite video signal complying with RS-170A or a black burst signal when using these connectors for the SD reference.

⑩ AUDIO IN connectors (CH1, CH2, CH3, CH4)

These are the input connectors for the analog audio signals.

⑪ AUDIO OUT/MONITOR connectors (CH1, CH2, CH3, CH4)

These are the output connectors for the analog audio signals.

The CH3 and CH4 connectors are also used as the audio monitor output connectors (left channel, right channel). (See page 7)

⑫ HD SDI IN, OUT connectors

These are the input and output connectors of the digital component audio and video signals complying with the SMPTE 292M, 296M or 299M standard.

⑬ REMOTE CONTROL connector

An external remote controller (AJ-A95, optional accessory) can be connected here to enable the VTR to be operated by remote control.

<Notes>

- Set the LOCAL/MENU/REMOTE switch to the REMOTE position.
- This connector complies with the RS-422A interface standard but the functions related to editing do not work.

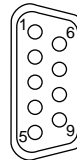

Pin No.	Signal
1	Frame Ground
2	Transmit A
3	Receive B
4	Receive Common
5	—
6	Transmit Common
7	Transmit B
8	Receive A
9	Frame Ground

⑭ Fan motor

This is for cooling the VTR.

⑮ Grip

Grips are provided on the side. These grips notwithstanding, the VTR should be installed on a level surface when it is to be operated.

Operation

Turning on the power and inserting the cassette

Before operating the VTR, check that the equipment has been connected correctly.
The VTR must be installed on a level surface for operation.

1 Turn on the power.

2 Insert the cassette tape.

Insert the tape into its prescribed position without forcing it into place.

3 Check that the STOP lamp has lighted.

When the tape is inserted, the cylinder starts rotating automatically, the tape is loaded, and the VTR is set to the STOP mode.

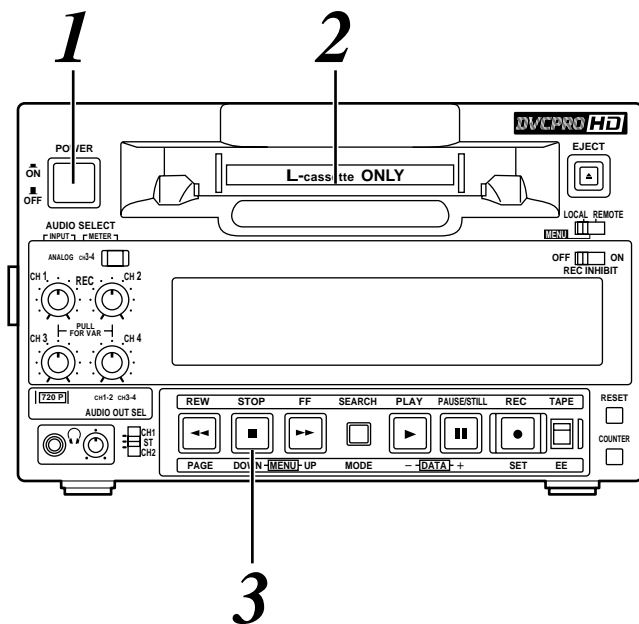

STOP mode

1 Press the STOP button to set the VTR to the STOP mode.

The STOP button lights, and the tape stops traveling.

- When the time set by setup menu item No.400 (STILL TIMER) has elapsed, the tape protection mode is established in order to protect the tape. When the STOP, REW, FF or PLAY button is pressed, the VTR is set to the corresponding mode.

<Caution concerning STILL TIMER setting>

The cumulative standby time in the same places on the tape lengthens when the same parts of the same tape are used repeatedly. To protect the tape, make the standby time in the same place as short as possible.

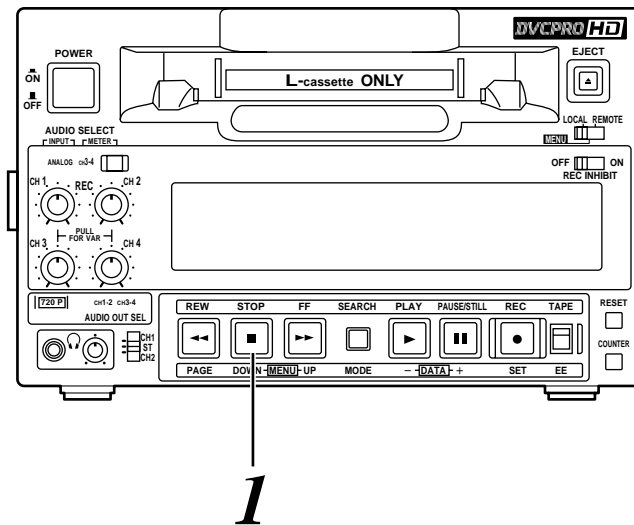

<Note>

When "ON" has been selected as the setup menu item No.104 setting, the STOP button will flash if the reference video signal is not input.

Recording

1 Set the cassette's accidental erasure prevention tab to the recording enable status, and insert the tape.

2 Press the STOP button to set the VTR to the stop mode.

3 **1. Selecting the input audio signals**

1) Connect the signals which are to be recorded.

2) Select the audio input signals using setup menu item No.700.

<Note>

For video signals, only HD SDI signals can be input.

2. Adjusting the analog audio level

Adjust the level of the audio input signals when analog audio signals have been selected as the audio input signals.

The audio signals are recorded at the appropriate level while the audio recording level controls remain pushed in.

<Note>

The recording level cannot be adjusted when HD SDI signals have been selected for the audio input signals.

4 Press the PLAY button while holding down the REC button.

The REC and PLAY lamps light, and recording is started.

When "ALL" has been selected as the setup menu item No.154 (AUTO BACK) setting, the tape is rewound for several seconds from the place where the REC and PLAY buttons were pressed and then, after a run-up, recording is started from the place where the REC and PLAY buttons were pressed. This ensures a smooth continuity from one image frame to the next.

5 To end the recording, press the STOP button.

The recording ends, and the VTR is set to the stop mode.

<Note>

During recording, check that the SERVO lamp is lighted. If it is flashing or off, the images will be subject to disturbances when they are played back.

Rec pause/recording (frame-to-frame continuity)

1 Press the PAUSE/STILL button while the cassette tape is playing.

2 Press the REC button to set the VTR to the REC PAUSE mode.

The monitor display is now switched to the E-E screen.

When "REC-P" or "ALL" has been selected as the setup menu item No.154 (AUTO BACK), the tape is rewound for several seconds from the place where the PAUSE/STILL button was pressed.

3 Press the PAUSE/STILL button to start the recording.

The tape runs up to the place where the PAUSE/STILL button was pressed in step 1, and recording is started.

<Note>

The E-E screen is now displayed.

4 Press the PAUSE/STILL button again to temporarily stop the recording.

When "REC-P" or "ALL" has been selected as the setup menu item No.154 (AUTO BACK), the tape is rewound for several seconds from the place where the PAUSE/STILL button was pressed, and then it is temporarily stopped.

5 Frame-to-frame continuity can be provided by repeating steps 3 and 4.

Operation

Playback

1 Insert the cassette tape.

2 Press the **PLAY** button.
Normal playback is started.

3 To end playback, press the **STOP** button.
The VTR is set to the stop mode.

<Notes>

- During playback, check that the SERVO lamp is lighted. If it is flashing or off, the images will be subject to disturbances when they are played back.
- The image will be disturbed for an instant when playback is initiated.

Cue (fast forward playback)/ review (reverse playback)

When the FF or REW button is pressed in a search mode (search still, FWD search, REV search, FWD search still or REV search still), the tape is cued or reviewed at the speed set by setup menu item No.150.

When the SEARCH button is pressed in the FF or REW mode, the tape decelerates to the speed set by setup menu item No.150, and the tape is cued or reviewed.

When the PAUSE/STILL button is pressed during cue or review, the tape is temporarily stopped. When it is pressed again, the cue or review is resumed.

VTR operating mode	Button pressed	Next VTR operation
Play or stop	SEARCH	Search still
	FF or REW	Fast forward or rewind
Fast forward	PLAY or STOP	Play or stop
	SEARCH	Forward search (fast forward playback)
Rewind	PLAY or STOP	Play or stop
	SEARCH	Reverse search (reverse playback)
Search still	PLAY or STOP	Play or stop
	FF	Forward search (fast forward playback)
	REW	Reverse search (reverse playback)
Forward search (fast forward playback)	SEARCH	Fast forward
	REW	Reverse search (reverse playback)
	PAUSE/STILL	Forward search still
Reverse search (reverse playback)	SEARCH	Rewind
	FF	Forward search (fast forward playback)
	PAUSE/STILL	Reverse search still
Forward search still	PAUSE/STILL, SEARCH or FF	Forward search (fast forward playback)
	REW	Reverse search (reverse playback)
Reverse search still	PAUSE/STILL, SEARCH or REW	Reverse search (reverse playback)
	FF	Forward search (fast forward playback)
All modes	PLAY	Play
	STOP	Stop

Still-picture playback

Press the PAUSE/STILL button during playback. When it is pressed again, normal playback is restored.

<Notes>

- No sound is heard during still-picture playback.
- Noise may appear on the still pictures.

Operation

Linear 0.3× speed playback

When the SEARCH button is pressed during still-picture playback (PLAY PAUSE), the VTR is set to the slow still mode.

When the FF or REW button is now pressed in this mode, the VTR is set to the linear 0.3× speed playback mode.

When the PAUSE/STILL button is pressed during linear 0.3× speed playback, the tape is temporarily stopped.

When the PAUSE/STILL button is pressed again, linear 0.3× speed playback is resumed.

Variable-speed playback

(when the AJ-A95 is connected)

When the AJ-A95 (optional accessory) is connected to the REMOTE connector, variable-speed playback can be performed by operating the search dial on the AJ-A95.

<Notes>

- Noise may appear on the screen at any playback speed other than 1× (normal speed).
- During variable-speed playback, the sound recorded on the analog cue track is played back.

VTR operating mode	Button pressed	Next VTR operation
Play	PAUSE/STILL	Play pause
Play pause	PAUSE/STILL or PLAY	Play
	SEARCH	Slow still
Slow still	PLAY	Play
	FF	Forward slow
	REW	Reverse slow
Forward slow	REW	Reverse slow
	SEARCH or PAUSE/STILL	Forward slow still
Reverse slow	FF	Forward slow
	SEARCH or PAUSE/STILL	Reverse slow still
Forward slow still	PAUSE/STILL, SEARCH or FF	Forward slow
	REW	Reverse slow
Reverse slow still	PAUSE/STILL, SEARCH or REW	Reverse slow
	FF	Forward slow
All modes	PLAY	Play
	STOP	Stop
All modes	STOP → FF	Fast forward
	STOP → REW	Rewind

Repeat playback

Setting the BEGIN point and END point

1 Set the VTR to the menu mode.
(By setting the LOCAL/MENU/REMOTE switch to the MENU position.)

2 Select setup menu item No.161 (BGN PRESET) or No.162 (END PRESET), and press the DATA+ button (PAUSE/STILL button) or DATA- button (PLAY button).

<Note>

A setting or no setting can be selected by operating the DATA+ and DATA- buttons.

“--:--:--:--” appears on the display with no setting. When repeat playback is performed in this status, the beginning of the tape serves as the BEGIN point and its end serves as the END point.

3 Use the COUNTER button to select TC or CTL.
<Note>

The display is reset to 00:00:00:00 when the RESET button is pressed.

4 Select the digit (indicated by the flashing display) to be changed using the UP button (FF button) or DOWN button (STOP button).

The frame digits cannot be selected. “00” is displayed for the frame at all times.

5 The value is changed by the DATA+ button (PAUSE/STILL button) and DATA- button (PLAY button).

6 Upon completion of the setting, press the SET button (REC button).

The setting is now stored in the memory.

<Note>

If the MODE button (SEARCH button) is pressed without pressing the SET button upon completion of the setting, the setting will not be stored in the memory, and the status existing prior to the setting will be restored.

7 Set the LOCAL/MENU/REMOTE switch to the LOCAL or REMOTE position.

Setting the repeat playback mode

1 Set the VTR to the menu mode.
(By setting the LOCAL/MENU/REMOTE switch to the MENU position.)

2 Select setup menu item No.160 (MEMORY MODE), and select the repeat playback mode.

Setting	Operation
OFF	Normal operation
M-STOP	The tape stops near the BEGIN point when it is fast forwarded or rewind.
REPT1	When the tape is played back to the END point, it is rewind to the BEGIN point where it stops.
CONT	When the tape is played back to the END point, it is rewind to the BEGIN point and played back again, and this process is repeated.

3 Set the LOCAL/MENU/REMOTE switch to the LOCAL or REMOTE position.

<Notes>

- The images will deteriorate when the same tape is played back in the repeat playback mode over and over again. After about 100 playback operations, replace the tape with a new one.
- The output image which appears when the tape returns to the BEGIN point in the repeat playback mode can be set using setup menu item No.163 (REPT MODE).
When “FREEZE” has been selected as the REPT MODE setting and if the END point is set at the tape end, the playback image will not freeze properly. Set this point on a part of the tape where images have been recorded.
- If the counter display mode (TC or CTL) established when the mode setting was selected by setup menu item No.161 (BGN PRESET) or No.162 (END PRESET) and the counter display mode (TC or CTL) for repeat playback do not match, the REPEAT lamp flashes, and the repeat playback operation is not performed.

Time Code & User's Bit

Time code

The time code signal is generated by the time code generator and recorded on the tape, and its value is read by the time code reader. The time code is used to display the absolute position of the tape in hour, minute, second and frame increments.

The time code is written in the sub-code area (data area) on the helical track. For this reason, the VTR's playback speed can be read out from the stop mode to the slow-motion playback to high-speed playback. The time code value is shown on the display and superimposed on the screen.

TCR	00 :	07 :	04 :	24
	↑	↑	↑	↑
	Hours	Minutes	Seconds	Frames

User's bit

The user's bit refers to the 32-bit (8-digit) information frame which is the only part of the time code signals open to the user for use. It can be used to record the operator number or other such information.

The alphanumeric characters which can be used for the user's bit are the numbers 0 through 9 and the upper-case letters A through F.

Setting the time code

- 1 Set the VTR to the menu mode.**
(By setting the LOCAL/MENU/REMOTE switch to the MENU position.)
- 2 Select "INT" as the setup menu item No.520 (TC MODE SW) setting.**
- 3 Select the setup menu item No.530 (TC PRESET) setting.**
- 4 The value of the first digit starts flashing when the DATA+ button (PAUSE/STILL button) or DATA- button (PLAY button) is pressed.**
- 5 When the MENU UP button (FF button) or MENU DOWN button (STOP button) is pressed, the digit to be changed moves, and the new digit starts flashing.**
- 6 Change the value by pressing the DATA+ button (PAUSE/STILL button) or DATA- button (PLAY button).**
- 7 Upon completion of the setting, press the SET button (REC button).**
(Operation now returns to the regular menu screen.)
- 8 Set the LOCAL/MENU/REMOTE switch to the LOCAL or REMOTE position.**

<Notes>

- The current value of the time code generator is displayed as the initial value.
- If the RESET button is pressed when "TC PRESET" has been set (while the number is still flashing), the display is reset to 00000000.
- The time code cannot be set when it has been set to "REGEN" by a combination of setup menu item No.503 (REGEN) and No.505 (TCG REGEN).
- If the MODE button (SEARCH button) is pressed without pressing the SET button upon completion of the setting, the time code setting will be canceled, and operation will return to the regular menu screen.

Time Code & User's Bit

Setting the user's bit

1 Set the VTR to the menu mode.
(By setting the LOCAL/MENU/REMOTE switch to the MENU position.)

2 Select the setup menu item No.531 (UB PRESET) setting.

The remaining steps are the same as for setting the time code.

Time code/user's bit playback

1 Set the VTR to the STOP mode.

2 Set TC or UB using the COUNTER button.

TC : The time code is displayed.

UB : The user's bit is displayed.

- When the time code can no longer be read, it is interpolated using the CTL signal.

3 Press the PLAY button.

Playback is started, and the time code appears on the display.

If "ON" has been selected as the setup menu item No.005 setting, the time code value is superimposed onto the video signals which are output from the VIDEO OUT2 connector.

<Notes>

- When the drop frame time code is read, the colon between the seconds and frames changes to a period.
- If the time code signal is missing, it is automatically compensated for by the CTL signal. What is displayed is shown below.

Superimposed display

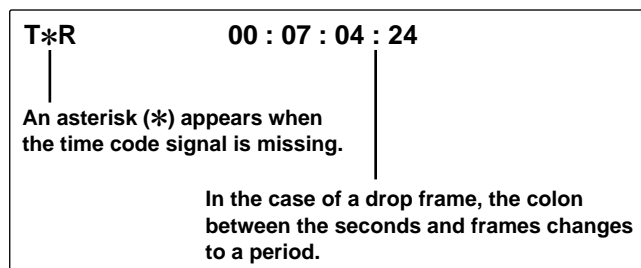

Counter display

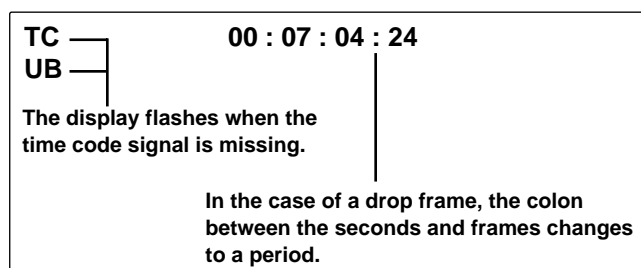

Superimposed Screens

When a TV monitor and the VIDEO OUT2 connector are connected, the abbreviations of the control signal, time code, etc. are displayed on the TV monitor. These displays can be turned ON or OFF using the setup menu item No.005 setting.

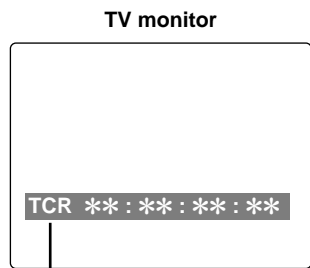

Abbreviations

- CTL** (control signal)
- TCR** (time code playback value)
- UBR** (user's bit playback value)
- REM** (remaining tape)

Display characters

The background of the characters used for the superimposed displays can be changed using the setup menu item No.009 (CHARA TYPE).



TV monitor

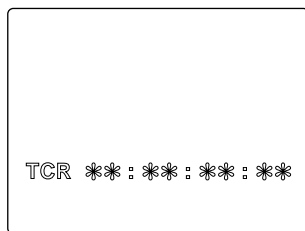

TV monitor

Display position

The position of the superimposed displays can be changed using the setup menu item No.007 (CHARA H-POS) and No.008 (CHARA V-POS) settings.



TV monitor

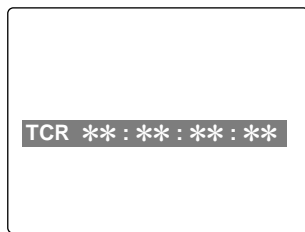

TV monitor

<Note>

When the PAGE button and DATA+ button or DATA- button are pressed, the counter display appears temporarily while the buttons are held down so that the settings can be checked.

It is also possible to proceed with the settings while checking the actual situation using the DATA+ button and DATA- button while the PAGE button is held down.

Operation mode

The content to be displayed can be selected using the setup menu item No.006 (DISPLAY SEL).

TIME : Counter value

T&STA : Counter value, VTR operation mode

T&S&M : Counter value, VTR operation mode, tape format or error message

TIME mode

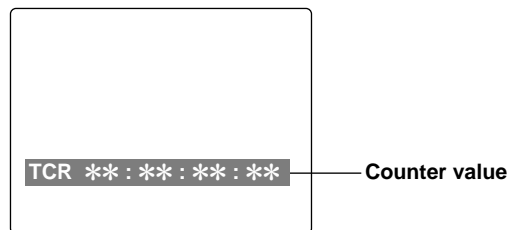

TV monitor

T&STA mode

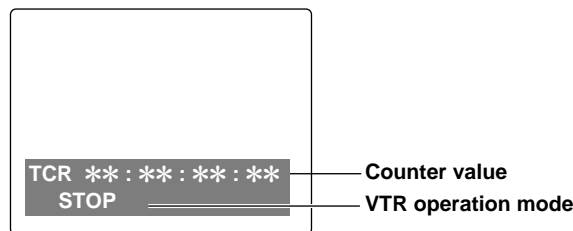

TV monitor

T&S&M mode

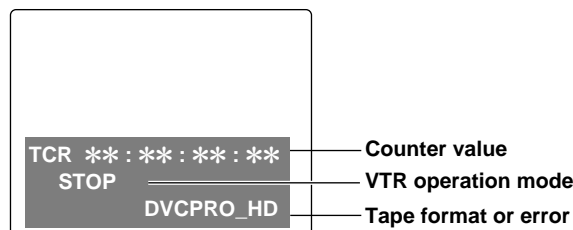

TV monitor

<Note>

In the VTR operation mode, "BOT" (beginning of tape) or "EOT" (end of tape) appears at the start of the line when the beginning or end of the tape has been detected.

Examples of displays:

EOT STOP

(stopped at the end of the tape)

BOT STANDBY OFF

(on standby at the beginning of the tape)

Setup (Initial Settings)

The VTR's main settings can be performed and checked using the on-screen menus which are displayed on the video monitor connected to the VTR. They can also be performed and checked using the item numbers and setting numbers which are displayed on the VTR's front panel display. The VTR comes with a user setting memory so that desired settings can be stored in the memory ahead of time and recalled for use at any time.

How to perform settings using the on-screen menu

1 Set the LOCAL/MENU/REMOTE switch to the MENU position.

The VTR is set to the menu setting mode, and the menu screen is displayed on the video monitor.

SET-UP MENU	MAIN
	NO.00
* 00 SYSTEM	
000 BASIC	
100 OPERATION	
200 INTERFACE	
400 TAPE PROTECT	
500 TIME CODE	
600 VIDEO	
700 AUDIO	
A00 MENU	

In the menu setting mode, the REW, STOP, FF, SEARCH, PLAY, PAUSE/STILL and REC control buttons function as the PAGE, MENU-DOWN, MENU-UP, MODE, DATA-, DATA+ and SET buttons, respectively.

2 Press the MENU-UP button or MENU-DOWN button to move the cursor (*) to the first menu item to be changed.

3 Press the MODE button, and select the setting for each item.

To return to the menu screen, press the MODE button while holding down the PAGE button.

4 Press the MENU-UP button or MENU-DOWN button to move the cursor (*) to the next menu item to be changed.

Pages can be scrolled up or down by pressing the MENU-UP button or MENU-DOWN button while holding down the PAGE button.

5 Press the DATA- or DATA+ button to change the setting.

6 Press the SET button to enter the setting.

To change multiple items, repeat steps 4, 5 and 6.

<Notes>

A setting can be canceled by pressing the MODE button.

To change another item without entering the setting, press the MODE button and then repeat steps 4, 5 and 6.

7 Set the LOCAL/MENU/REMOTE switch to the LOCAL or REMOTE position.

This completes the menu settings.

How to return to the factory settings

1 Set the LOCAL/MENU/REMOTE switch to the MENU position.

The VTR is set to the menu setting mode, and the menu screen is displayed on the video monitor.

2 Press the RESET button.

The VTR is set to the default setting mode, and the default setting screen is displayed on the video monitor.

SELECT MODE
* 0 ESCAPE
1 LOAD
2 SAVE
3 PROTECT

Setup (Initial Settings)

- 3** Press the MENU-UP button or MENU-DOWN button to move the cursor to the LOAD position, and press the SET button.

The VTR is set to the LOAD mode, and the LOAD screen is displayed on the video monitor.

```
SET-UP MENU    <LOAD>
               * NO
               FACTORY
               USER (ALL)
               USER (NOT SYSTEM)
```

- 4** Press the MENU-UP button or MENU-DOWN button to move the cursor to FACTORY, and press the SET button.

- If the cursor is moved to FACTORY and this operation is performed, the factory settings are restored for all the menus with the exception of the SYSTEM menu.
- If the cursor is moved to NO and this operation is performed, operation returns to the menu screen without restoring the factory settings.

- 5** Set the LOCAL/MENU/REMOTE switch to the LOCAL or REMOTE position.

This completes the menu settings.

- 4** Press the MENU-UP button or MENU-DOWN button to move the cursor to the SAVE position, and press the SET button.

The VTR is set to the SAVE mode, and the SAVE screen is displayed on the video monitor.

```
SET-UP MENU    <SAVE>
               * NO
               USER (ALL)
               USER (NOT SYSTEM)
```

- 5** Press the MENU-UP button or MENU-DOWN button to move the cursor to USER (ALL), and press the SET button.

- If the cursor is moved to USER (NOT SYSTEM) and this operation is performed, the settings are updated for all the menus with the exception of the SYSTEM menu.
- If the cursor is moved to NO and this operation is performed, operation returns to the menu screen without updating the settings.

- 6** The screen on which SAVE is checked now appears. Press the MENU-UP button or MENU-DOWN button to move the cursor to the YES position, and press the SET button.

The settings are now stored in the memory.

```
SAVE OK?
          * NO
          YES
```

- 7** Set the LOCAL/MENU/REMOTE switch to the LOCAL or REMOTE position.

This completes the menu settings.

How to set the user defaults

- 1** Set the LOCAL/MENU/REMOTE switch to the MENU position.

The VTR is set to the menu setting mode, and the menu screen is displayed on the video monitor.

- 2** Perform steps 2 through 6 in “How to perform settings using the on-screen menu,” and change to the desired settings.

- 3** Press the RESET button.

The VTR is set to the default setting mode, and the default setting screen is displayed on the video monitor.

```
SELECT MODE
          * 0 ESCAPE
          1 LOAD
          2 SAVE
          3 PROTECT
```

Setup (Initial Settings)

How to load the user defaults

1 Set the LOCAL/MENU/REMOTE switch to the MENU position.

The VTR is set to the menu setting mode, and the menu screen is displayed on the video monitor.

2 Press the RESET button.

The VTR is set to the default setting mode, and the default setting screen is displayed on the video monitor.

```
SELECT MODE
  * 0 ESCAPE
    1 LOAD
    2 SAVE
    3 PROTECT
```

3 Press the MENU-UP button or MENU-DOWN button to move the cursor to the LOAD position, and press the SET button.

The VTR is set to the LOAD mode, and the LOAD screen is displayed on the video monitor.

```
SET-UP MENU  <LOAD>
  * NO
    FACTORY
    USER (ALL)
    USER (NOT SYSTEM)
```

4 Press the MENU-UP button or MENU-DOWN button to move the cursor to USER (ALL), and press the SET button.

- If the cursor is moved to USER (NOT SYSTEM) and this operation is performed, operations are performed using the user settings stored in the memory for all the menus with the exception of the SYSTEM menu.
- If the cursor is moved to NO and this operation is performed, operation returns to the menu screen while the user settings stored in the memory remain unchanged.

5 Set the LOCAL/MENU/REMOTE switch to the LOCAL or REMOTE position.

This completes the menu settings.

How to protect the menus

By setting the unit to the menu protection mode, opening of the setup menus can be prevented even when the LOCAL/MENU/REMOTE switch on the front panel has been set to the MENU position.

1 Set the LOCAL/MENU/REMOTE switch to the MENU position.

The VTR is set to the menu setting mode, and the menu screen is displayed on the video monitor.

2 Press the RESET button.

The VTR is set to the default setting mode, and the default setting screen is displayed on the video monitor.

```
SELECT MODE
  * 0 ESCAPE
    1 LOAD
    2 SAVE
    3 PROTECT
```

3 Press the MENU-UP button or MENU-DOWN button to move the cursor to the PROTECT position, and press the SET button.

The VTR is set to the menu protection setting mode, and the screen for checking the menu protection function is displayed on the video monitor.

```
MENU PROTECT OK?
  * NO
    YES
```

4 Press the MENU-UP button or MENU-DOWN button to move the cursor to YES, and press the SET button.

The menu screen now appears.

Setup (Initial Settings)

5 Set the LOCAL/MENU/REMOTE switch to the LOCAL or REMOTE position.

The unit is now set to the menu protection mode. When the LOCAL/MENU/REMOTE switch is set to the MENU position, the VTR is not set to the menu setting mode, and "MENU PROTECTED" appears on the video monitor screen.

<Notes>

If, while the menu protection mode is being set, the LOCAL/MENU/REMOTE switch is set to the MENU position while the COUNTER button on the front panel is pressed, the unit is set to the menu setting mode, and regular menu settings can be performed.

Perform steps 2 through 7 of "How to perform settings using the on-screen menu."

How to release the menu protection

1 Set the LOCAL/MENU/REMOTE switch to the MENU position while pressing the COUNTER button on the front panel.

The unit is set to the menu setting mode, and the menu screen is displayed on the video monitor.

2 Perform steps 2 and 3 of "How to protect the menus."

The screen for checking the menu protection function is displayed on the video monitor.

```
MENU PROTECT OK?
* NO
  YES
```

3 Press the MENU-UP button or MENU-DOWN button to move the cursor to NO, and press the SET button.

The menu protection function is now released.

How to display the DIAG menu

This unit comes with a function for displaying the "HOURS METER," software "VERSION" and the deck's serial number on the video monitor.

1 Set the LOCAL/MENU/REMOTE switch to the MENU position while pressing the EJECT button.

The unit is set to the DIAG display mode, and the hours meter and deck's serial number are displayed on the video monitor.

DIAG-MENU	HOURS METER
Ser	*****
H00	OPERATION 00000H
H01	DRUM RUN 00000H
H02	TAPE RUN 00000H
H03	THREADING 00000T
H11	DRUM RUN r 00000H
H12	TAPE RUN r 00000H
H13	THREADING r 00000T
END	

Items with "r" can be reset when servicing is performed.

2 While the hours meter is displayed, press the MENU-UP button or MENU-DOWN button while pressing the PAGE button.

The software version is displayed on the video monitor.

DIAG-MENU	VERSION
<NTSC>	
FRONT	1.**-**
IF	1.**-**-**
AV-SYSCON	1.**-**-**
SERVO	1.**-**-**
END	

The hour meter display is restored by pressing the MENU-UP button or MENU-DOWN button again while pressing the PAGE button.

3 Set the LOCAL/MENU/REMOTE switch to the LOCAL or REMOTE position.

Operation now returns to the regular mode.

001	LOCAL ENA		For setting the buttons which can be operated on the front panel when the LOCAL/MENU/REMOTE switch is at the REMOTE position.
		0000	DIS 0: No buttons can be operated.
		<u>0001</u>	<u>ST&EJ</u> 1: Only the STOP and EJECT buttons can be operated.
		0002	ENA 2: All the buttons can be operated except for COUNTER and RESET.
002	TAPE TIMER		For setting the time system on the CTL counter display.
		<u>0000</u>	<u>±12h</u> 0: 12-hour system
		0001	24h 1: 24-hour system
003	REMAIN SEL		For setting the superimposing of the remaining tape time and total tape length displays for the VIDEO OUT2 connector.
		0000	OFF 0: No superimposed displays
		<u>0001</u>	<u>2L</u> 1: Remaining tape time is displayed on the second line.
		0002	1L 2: Remaining tape time is displayed on the first line.
		0003	R/TTL 3: Remaining tape time is displayed on the first line and the total tape length on the second line.
			<Notes>
			<ul style="list-style-type: none"> • When “2L” has been selected as this item’s setting, the time will not be displayed even if “TIME” was selected as the menu item No.006 (DISPLAY SEL) setting. • Even when “R/TTL” has been selected as this item’s setting, the total tape length will not be displayed if “TIME” has been selected as the menu item No.006 (DISPLAY SEL) setting.
005	SUPER		For setting whether the displays are to be superimposed onto the VIDEO OUT2 connector.
		0000	OFF 0: The displays are not superimposed.
		<u>0001</u>	<u>ON</u> 1: The displays are superimposed.
006	DISPLAY SEL		For setting what displays are to be superimposed onto the VIDEO OUT2 connector.
		0000	TIME 0: Only the time display is superimposed.
		<u>0001</u>	<u>T&STA</u> 1: The time and operation status are superimposed.
		0002	T&S&M 2: The time, operation status and mode are superimposed.
			<Note>
			When “T&S&M” has been selected as this item’s setting and a warning or error occurs, an error message is superimposed.
007	CHARA H-POS	0000	
		:	
		:	

<Notes>

- If the PAGE button and the DATA+ or DATA– button are pressed together when menu item No.007 (CHARA H-POS) and No.008 (CHARA V-POS) are being set, the counter display appears temporarily while these buttons are held down to enable the settings to be checked. It is also possible to use the DATA+ button and DATA– button while holding down the PAGE button to perform the settings while at the same time checking their actual status.
- Even when “OFF” is selected as the menu item No.005 (SUPER) setting, the superimposing is displayed in accordance with the menu No.006 (DISPLAY SEL) setting while the menu settings are being performed. When the menu setting process is exited, the display accords with the menu item No.005 (SUPER) setting.

Setup Menus

BASIC

Item		Setting		Description of setting
No.	Superimposed display	No.	Superimposed display	
009	CHARA TYPE	<u>0000</u> 0001	<u>WHITE</u> W/OUT	For setting the superimposed display and the menu display type. 0: White characters are displayed on a black background. 1: White characters with black borders are displayed.
020	SYS FORMAT	<u>0000</u> 0001	<u>1080i</u> 720p	For setting the format used to record and play back signals including the HD REF signal. 0: 1080i mode 1: 720p mode
022	PB FORMAT	<u>0000</u> 0001	<u>MANUAL</u> AUTO	For setting the format used for playing back the tape. 0: The menu item No.020 (SYS FORMAT) setting is complied with. 1: The format in which the recording on the tape was performed is complied with.

The underlining denotes the factory mode.

Setup Menus

OPERATION

Item		Setting		Description of setting
No.	Superimposed display	No.	Superimposed display	
101	SHTL MAX	<u>0000</u> <u>0001</u>	X8.4 <u>X16</u>	For setting the maximum shuttle mode speed when using the external controller connected to the 9-pin remote connector. 0: 8.4× normal speed 1: 16× normal speed
104	REF ALARM	<u>0000</u> <u>0001</u>	OFF <u>ON</u>	For setting whether the warnings are to be indicated when the REF VIDEO has not been connected. 1: No warnings are indicated. 2: Warnings are indicated by the STOP lamp which flashes.
106	EJECT EE SEL	<u>0000</u> 0001	<u>EE</u> BLANK	For setting the video and audio output statuses when the tape is ejected. 0: The signals are always output in the E-E (electric modulation to electric playback) mode regardless of the position of the TAPE/EE switch. 1: The output status changes according to the position of the TAPE/EE switch. EE : The signals are output in the E-E mode. TAPE : A blank is output for the video signals, and the audio signals are muted.
110	AUTO REW	<u>0000</u> <u>0001</u>	OFF <u>ON</u>	For setting whether the tape is to be rewound automatically to its start when the tape-end has been detected. 0: The tape is not rewound. 1: The tape is rewound to its start.
112	FRZ MODE SEL	<u>0000</u> <u>0001</u>	<u>DIS</u> STBOFF	For setting the video output when the mode has moved from playback images to the STANDBY OFF (half loading) mode. 0: The video output is muted. 1: The playback image appearing at the moment when the STANDBY OFF (half loading) mode is established is frozen and output.
114	REC INH LAMP	<u>0000</u> <u>0001</u>	<u>LIGHT</u> FLASH	For setting the REC INHIBIT lamp operation when the cassette is set to the accidental erasure prevention mode. 0: The lamp lights. 1: The lamp flashes. <Notes> The REC INHIBIT lamp always lights regardless of this setting when the REC INHIBIT switch on the front panel is set to the ON position.
115	EJECT SW INH	<u>0000</u> 0001	<u>REC</u> OFF	For setting a restriction on the operation of the front panel's EJECT button. 0: Operating the button is prohibited while the recording mode is established. 1: The button can be operated in any mode.
117	M CASSTT INH	<u>0000</u> <u>0001</u>	OFF <u>ON</u>	For setting a restriction on recording onto M-size cassette tapes. 0: Recording onto M-size cassette tapes is permitted. 1: Recording onto M-size cassette tapes is prohibited.
150	SEARCH SPEED	<u>0000</u> <u>0001</u>	<u>X4.1</u> X8.4	For setting the speed at which the tape is to decelerate when the front panel's search button is pressed. 0: 4.1× normal speed 1: 8.4× normal speed
152	HUMID OPE	<u>0000</u> <u>0001</u>	OFF <u>ON</u>	For setting the operation to be performed when condensation has formed. 0: The unit does not operate when condensation has formed. 1: The unit can be operated when condensation has formed but no guarantee is made that it will operate properly. <Note> Due to the possibility of tape damage and other problems, select the "0: Unit does not operate" setting for normal operation.

The underlining denotes the factory mode.

Setup Menus

OPERATION

Item		Setting		Description of setting
No.	Superimposed display	No.	Superimposed display	
154	AUTO BACK	0000 <u>0001</u> 0002	OFF REC-P ALL	For setting the operation method used for the frame-to-frame continuity function. (This item activates the AUTO BACK function to rewind the tape for several seconds in order to ensure a smooth continuity between the recorded images.) 0: No AUTO BACK operation. 1: In the REC PAUSE mode, the AUTO BACK function is activated, and the tape stops in the recording standby mode. (When PAUSE is released, the tape runs up and recording starts.) 2: In addition to the menu item No.0001 (REC-P) function, the AUTO BACK function is activated in the REC PLAY mode, the tape runs up immediately, and recording starts.
160	MEMORY MODE	0000 <u>0001</u> 0002 0003	OFF M-STOP REPT1 CONT	For setting the repeat playback mode. 0: No repeat playback (normal operation). 1: The tape stops near the BEGIN point when it is fast forwarded or rewind. 2: When the tape reaches the END point, it is rewind to the BEGIN point where it stops. 3: When the tape reaches the END point, it is rewind to the BEGIN point and played, and this process is repeated.
161	BGN PRESET (CTL or TC)			For setting the BEGIN point in the repeat playback mode. The counter display mode is set to either TC or CTL by the COUNTER button. When the BEGIN point is not set, "--:--:--:--" appears on the display, and the beginning of the tape serves as the BEGIN point.
162	END PRESET (CTL or TC)			For setting the END point in the repeat playback mode. The counter display mode is set to either TC or CTL by the COUNTER button. When the END point is not set, "--:--:--:--" appears on the display, and the tape end serves as the END point.
163	REPT MODE	0000 0001 <u>0002</u>	<u>FREEZE</u> BLACK SW	For setting what image is to be output when the tape returns to the BEGIN point in the repeat playback mode. 0: The tape returns to the BEGIN point while the playback image at the END point remains frozen. 1: The tape returns to the BEGIN point while the picture remains black. 2: The tape returns to the BEGIN point in accordance with the TAPE/EE switch setting. <Note> If the END point is set at the tape end when "0: FREEZE" has been selected, the playback image will not be frozen properly. Set the END point within the range of the tape where images are recorded.
180	BATTERY SEL	0000 0001 <u>0002</u>	NiCd12 NiCd13 NiCd14	For setting the battery type. 0: 12 V type of battery 1: 13 V type of battery 2: 14 V type of battery

The underlining denotes the factory mode.

Setup Menus

INTERFACE

Item		Setting		Description of setting
No.	Superimposed display	No.	Superimposed display	
202	ID SEL	<u>0000</u> 0001 0002	<u>OTHER</u> DVCPRO ORIG	For setting the ID information to be returned to the controller. 0: 20 25H is returned. 1: The ID (F0 33H) unique to the DVCPRO is returned. 2: The ID (A0 51H) unique to the unit is returned.

The underlining denotes the factory mode.

TAPE PROTECT

Item		Setting		Description of setting
No.	Superimposed display	No.	Superimposed display	
400	STILL TIMER	0000 0001 0002 0003 0004 0005 0006 0007 <u>0008</u>	0.5S 5S 10S 20S 30S 40S 50S 1min <u>2min</u>	For setting the time taken before the unit is set to the tape protection mode when it has been left in the STOP or STILL mode. (Unit: S = seconds, min: minutes)
401	SRC PROTECT	<u>0000</u> 0001	<u>STEP</u> HALF	For setting the tape protection mode operation when the unit has been left in the STILL mode. 0: STEP FWD 1: STANDBY OFF (half loading) <Note> When STEP FWD has been set, the unit is automatically transferred to the STANDBY OFF (half loading) mode when it has been left in the STILL mode for a total of 30 minutes.
402	DRUM STDBY	0000 <u>0001</u>	OFF <u>ON</u>	For setting the drum operation in the STANDBY OFF (half loading) mode. 0: The drum stops rotating. 1: The drum continues to rotate.
403	STOP PROTECT	0000 <u>0001</u>	STEP <u>HALF</u>	For setting the tape protection mode operation when the unit has been left in the STOP mode. 0: STEP FWD 1: STANDBY OFF (half loading) <Note> When STEP FWD has been set, the unit is automatically transferred to the STANDBY OFF (half loading) mode when it has been left in the STOP mode for a total of 30 minutes.

The underlining denotes the factory mode.

Setup Menus

TIME CODE

Item		Setting		Description of setting
No.	Superimposed display	No.	Superimposed display	
500	VITC BLANK	0000 <u>0001</u>	BLANK THRU	For setting whether to output the VITC signal to the position set by menu item No.501 (VITC POS-1) and No.502 (VITC POS-2). 0: The VITC signal is not output. 1: The VITC signal is output. <Note> This setting is only effective for SD outputs (VIDEO output and SD SDI output).
501	VITC POS-1	0000 : <u>0006</u> : 0010	10L : <u>16L</u> : 20L	For setting the position where the VITC signal is to be inserted. <Notes> ● The same line as that set for menu item No.502 (VITC POS-2) cannot be set. ● This setting is only effective for SD outputs (VIDEO output and SD SDI output).
502	VITC POS-2	0000 : <u>0008</u> : 0010	10L : <u>18L</u> : 20L	For setting the position where the VITC signal is to be inserted. <Notes> ● The same line as that set for menu item No.501 (VITC POS-1) cannot be set. ● This setting is only effective for SD outputs (VIDEO output and SD SDI output).
503	REGEN	<u>0000</u> 0001	<u>REGEN</u> PRE	For setting the synchronization method of the internal time code generator. 0: The time code reader is synchronized to the time code which is read from the tape. 1: The synchronization method can be preset by a front panel operation or using the remote controller.
504	RUN MODE	0000 <u>0001</u>	<u>REC</u> FREE	For setting the operation mode in which the internal time code generator advances the time code. 0: The generator advances only during recording. 1: It advances while the power is on regardless of the operation mode.
505	TCG REGEN	<u>0000</u> 0001 0002	<u>TC&UB</u> TC UB	For setting the signal to be regenerated when the TCG (time code generator) is in the regeneration mode. 0: Both the time code and user's bit are regenerated. 1: Only the time code is regenerated. 2: Only the user's bit is regenerated.
508	BINARY GP	<u>0000</u> 0001 0002 0003 0004 0005 0006 0007	<u>000</u> 001 010 011 100 101 110 111	For setting the conditions under which the user's bit in the time code generated by TCG is to be used. 0: Not specified (character set is not specified). 1: ISO characters (8-bit character set compliant with ISO646, ISO2022) 2: Unassigned 1 (not defined) 3: Unassigned 2 (not defined) 4: Unassigned 3 (not defined) 5: Page/line 6: Unassigned 4 (not defined) 7: Unassigned 5 (not defined)
509	PHASE CORR	<u>0000</u> 0001	<u>OFF</u> ON	For setting whether to control the phase compensation for the LTC output during playback. 0: The phase compensation is not controlled. 1: The phase compensation is controlled.

The underlining denotes the factory mode.

Setup Menus

511 DF MODE

0000
0001

For setting the DF or NDF mode for CTL and TCG.
DF 0: The drop frame mode is used.
NDF 1: The non-drop frame mode is used.
<Note>

Setup Menus

VIDEO

Item		Setting		Description of setting
No.	Superimposed display	No.	Superimposed display	
603	V-MUTE SEL	0000 <u>0001</u>	N-MUTE GRAY	For setting whether to mute the video output signal when a blank part of the tape has been detected during playback. 0: The video output signal is not muted (the image is frozen). 1: The video output signal is muted (the screen is turned gray).
620	DOWNCON MODE	0000 0001 0002 0003 0004	FIT_V FIT_H FIT_HV 14:9 13:9	For setting the image processing which is to be performed during down-conversion. 0: Side cut mode 1: Letter-box mode 2: Squeeze mode 3: Semi letter-box mode 14:9 4: Semi letter-box mode 13:9 <Note> While the setting is being adjusted, the sound output will be muted; however this is normal and not indicative of a problem. When the adjustment is finished, sound will be output.
645	D/C ENH	0000 <u>0001</u>	OFF ON	For setting whether to enhance the contours during down-conversion. 0: The contours are not enhanced. 1: The contours are enhanced.
672	V OUT SETUP	0000 <u>0001</u> 0002 0003	THRU <u>ADD22L</u> ADD21L ADD20L	For setting the setup processing for the composite output signal. 0: The original signal is output as is. 1: A 7.5% setup is added from line 22 of the output signal and output. 2: A 7.5% setup is added from line 21 of the output signal and output. 3: A 7.5% setup is added from line 20 of the output signal and output.
673	EDH	0000 <u>0001</u>	OFF ON	For setting whether to superimpose EDH onto the SD SDI output. 0: EDH is not superimposed. 1: EDH is superimposed.

The underlining denotes the factory mode.

Setup Menus

AUDIO

Item		Setting		Description of setting
No.	Superimposed display	No.	Superimposed display	
700	AUDIO IN SEL	0001 <u>0002</u>	ANA SDI	For setting the audio signal input (for all the channels at the same time). 1: Fixed to the analog signal input. 2: Fixed to the SDI signal input. <Note> When analog signals are input, they are recorded on the tape's audio tracks listed below depending on the channels to which they are input. CH1 input → CH1 and CH5 tracks CH2 input → CH2 and CH6 tracks CH3 input → CH3 and CH7 tracks CH4 input → CH4 and CH8 tracks
701	CH1 IN LV	0000 <u>0001</u> 0002 0003	4dB 0dB -20dB -60dB	For setting the reference level of the analog audio input (CH1).
702	CH2 IN LV	0000 <u>0001</u> 0002 0003	4dB 0dB -20dB -60dB	For setting the reference level of the analog audio input (CH2).
703	CH3 IN LV	0000 <u>0001</u> 0002 0003	4dB 0dB -20dB -60dB	For setting the reference level of the analog audio input (CH3).
704	CH4 IN LV	0000 <u>0001</u> 0002 0003	4dB 0dB -20dB -60dB	For setting the reference level of the analog audio input (CH4).
706	CH1 OUT LV	0000 <u>0001</u> 0002	4dB 0dB -20dB	For setting the reference level of the analog audio output (CH1).
707	CH2 OUT LV	0000 <u>0001</u> 0002	4dB 0dB -20dB	For setting the reference level of the analog audio output (CH2).
708	CH3/L OUT LV	0000 <u>0001</u> 0002	4dB 0dB -20dB	For setting the reference level of the analog audio output (CH3/L).
709	CH4/R OUT LV	0000 <u>0001</u> 0002	4dB 0dB -20dB	For setting the reference level of the analog audio output (CH4/R).

The underlining denotes the factory mode.

Setup Menus

AUDIO

Item		Setting		Description of setting
No.	Superimposed display	No.	Superimposed display	
730	REC CUE	0001 0002 0003 0004 0005 0006 0007 0008 <u>0009</u> 0010 0011 0012 0013	CH1 CH2 CH3 CH4 CH5 CH6 CH7 CH8 CH1+2 CH3+4 CH5+6 CH7+8 CH1-8	For setting the input signal to be recorded on the cue track. 1: Audio input CH1 2: Audio input CH2 3: Audio input CH3 4: Audio input CH4 5: Audio input CH5 6: Audio input CH6 7: Audio input CH7 8: Audio input CH8 9: Audio input CH1 and CH2 mixed signals 10: Audio input CH3 and CH4 mixed signals 11: Audio input CH5 and CH6 mixed signals 12: Audio input CH7 and CH8 mixed signals 13: Audio input CH1 through CH8 mixed signals
731	PB FADE	<u>0000</u> 0001 0002	AUTO CUT FADE	For setting the processing to be performed at the audio edit points (IN and OUT points) and frame-to-frame continuity points during playback. 0: Processing accords with the status during recording. 1: Cut processing is forcibly performed. 2: Fade processing is forcibly performed.
732	EMBEDDED AUD	0000 <u>0001</u>	OFF ON	For setting whether the audio data is to be superimposed onto the HD SDI output and SD SDI output. 0: The audio data is not superimposed. 1: The audio data is superimposed.
765	CUE OUT SEL	<u>0000</u> 0001	OFF ON	For setting the analog cue signal output to the audio output (main line). 0: The analog cue signal is not output. PCM sound is output in the playback mode, and no sound is output in any other mode. 1: The analog cue signal is output. PCM sound is output in the playback mode, and the analog cue sound is output in any other mode.
769	MONI SEL	<u>0000</u> 0001	PLYPCM PLYCUE	For setting the monitor output sound during playback. 0: PCM sound is output. 1: Cue sound is output.
770	MONITOR MIX	<u>0000</u> 0001	STEREO CH1+2	For setting the audio monitor output sound. (This functions when the audio monitor selector switch on the front panel is at the "ST" position.) 0: Stereo sound is output. 1: Mixed sound is output (for both the L and R connectors).
771	H.PHONE MIX	<u>0000</u> 0001	STEREO CH1+2	For setting the headphone output sound. (This functions when the audio monitor selector switch on the front panel is at the "ST" position.) 0: Stereo sound is output. 1: Mixed sound is output (when monaural earphones are used).

The underlining denotes the factory mode.

Setup Menus

AUDIO

Item		Setting		Description of setting
No.	Superimposed display	No.	Superimposed display	
780	AUD OUT SEL	<u>0000</u>	<u>LINE</u>	For setting the output sound of the analog audio output connectors. 0: All the output connectors are used as the main line output. CH1 connector = CH1 sound CH2 connector = CH2 sound CH3 connector = CH3 sound CH4 connector = CH4 sound 1: The CH1 and CH2 output connectors are used as the main line output, and the CH3 and CH4 output connectors are used as the monitor output connectors. CH1 connector = CH1 sound CH2 connector = CH2 sound CH3 connector = Monitor L (CH1, CH2, CH1+CH2) sound CH4 connector = Monitor R (CH1, CH2, CH1+CH2) sound 2: The CH1 and CH2 output connectors are used as the main line output, and the CH3 and CH4 output connectors are used as the monitor output connectors. CH1 connector = CH3 sound CH2 connector = CH4 sound CH3 connector = Monitor L (CH3, CH4, CH3+CH4) sound CH4 connector = Monitor R (CH3, CH4, CH3+CH4) sound
		0001	CH1/2	
		0002	CH3/4	
781	IN IMP SEL	0000 <u>0001</u>	600 <u>HIGH</u>	For setting the impedance of the analog audio input. 0: 600 Ω 1: High impedance <Note> Regardless of the setting selected here, the impedance is set to 3 kΩ when -60 dB has been selected as the menu item No.701 to 704 (CH1 to CH4 IN LV) settings.

The underlining denotes the factory mode.

MENU

Item		Setting		Description of setting
No.	Superimposed display	No.	Superimposed display	
A02	P.ON LOAD	0000 <u>0001</u>	OFF <u>ON</u>	For setting whether to change the setup menu settings to the user's initial settings when the power is turned on. 0: The settings are not changed. 1: The settings are changed.

The underlining denotes the factory mode.

Error Messages

When a problem has occurred in the unit, one of the following messages will appear on the front panel's counter display and superimposed display on the monitor.

With the superimposed display, the error number is indicated in the part where the counter value is displayed.

When "T&S&M" has been selected as the setup menu item No.006 setting, the error message appears in the part of the superimposed display where the mode is displayed.

Error No.	Error message and description
--d--	DEW Condensation has formed. The unit can still be operated if "ON" has been selected as the setup menu item No.152 (HUMID OPE) setting. The counter value and "--d--" appear alternately on the front panel counter display.
E-00	SERVO NOT LOCKED This appears when the servo lock has been disengaged for 3 or more seconds during playback or recording.
E-01	LOW RF This appears when the head output is not supplied (due to head clogging, etc.) for 1 or more seconds during playback.
E-02	HIGH ERROR RATE This appears when the error rate has deteriorated, and the video or audio playback signals have been corrected or interpolated.
E-09	NO RF This appears when a tape blank has been detected for 1 or more seconds during playback. A state in which all of the following conditions are satisfied is recognized as a blank. <ul style="list-style-type: none"> • No output from any of the heads. • Playback data cannot be read. • No CTL signal.
E-10	FAN STOP This appears when the fan motor has stopped. The power is automatically turned off when 5 or so minutes have elapsed since the motor stopped.
E-29	FRONT LOAD MOTOR This appears when the cassette fails to rise even when 6 seconds have elapsed after the unit was transferred to the eject mode.
E-31	LOADING MOTOR This appears when the unloading operation fails to be completed within 6 seconds.
E-51	FRONT LOAD ERROR This appears when the take-up reel has continued to rotate without engaging with the tape for a specific period of time during the start or end processing operation performed midway through loading (half position).
E-52	W-UP REEL NOT ROTA This appears when the take-up reel fails to take up the tape while the tape is traveling in a state where its total tape length has not been detected after the cassette was inserted.
E-53	WINDUP ERROR This appears when there is an abnormal difference between the tape take-up amount on the take-up reel and the amount of tape supplied from the supply reel while the tape is traveling after the total tape length was detected.

Error No.	Error message and description
E-55	UNLOAD ERROR This appears when the tape has not been taken up during unloading.
E-57	S-FF/REW TIMEOVER This appears when the tape start or end processing operation fails to be completed.
E-59	DRUM ROTA TOO SLOW This appears when the rotational speed of the cylinder motor is abnormally low.
E-60	DRUM ROTA TOO FAST This appears when the rotational speed of the cylinder motor is abnormally high.
E-61	CAP ROTA TOO SLOW This appears when the rotational speed of the capstan motor is abnormally low.
E-64	S REEL TOO FAST This appears when the rotational speed of the supply reel motor is abnormally high.
E-67	T REEL TOO FAST This appears when the rotational speed of the take-up reel motor is abnormally high.
E-69	T REEL TORQUE ERR This appears when the application of an abnormal torque has been detected at the take-up reel motor.
E-6A	This error number appears on the front panel counter display when a communication error has occurred between the IF and FRONT microcomputers. The superimposed display itself is cleared from the monitor screen.
E-6B	FRP ERROR This appears when an error has occurred in the microcomputer reference signal.
E-70	S REEL TORQUE ERR This appears when the application of an abnormal torque has been detected at the supply reel motor.
E-71	CAP TENSION ERROR This appears when abnormal supply reel tension has been detected in the capstan mode.
E-72	REEL TENSION ERROR This appears when abnormal supply reel tension has been detected in the reel mode.
E-73	REEL DIR UNMATCH This appears when the take-up reel motor is rotated in the wrong direction.
E-bA	BATTERY This appears when the input DC voltage has dropped below the lower voltage limit (approx. 10.6 V).

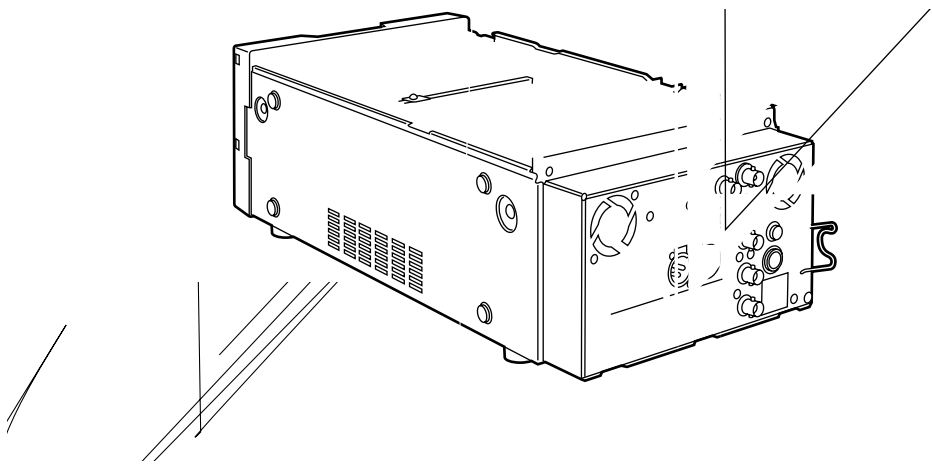

Video Head Cleaning

This unit is equipped with an auto head cleaning function, which automatically reduces the amount of dirt on the video heads. However, in order to enhance the unit's reliability, it is recommended that the video heads be cleaned every day. Use a cleaning fluid designated by the unit's manufacturer.

Condensation

The same principle by which droplets of water form on a window pane of a heated room is responsible for the formation of condensation inside the unit.

Condensation occurs in the unit or tape when it is moved from one location to another where there is a significant difference in temperature and humidity.

More specifically, it forms:

- When the unit (or tape) is moved to a very humid location where the air is full of steam, or to a room immediately after it has been heated
- When the unit (or tape) is abruptly moved from an air-conditioned location to a very warm or very humid location

When moving the unit to the kind of location described above, do not turn on its power immediately but leave it standing for about 10 minutes. If condensation has formed inside the unit, an error message (— d —) will light up on the counter display, and the cassette tape will be automatically ejected.

Leave the power on, and wait until the error message is cleared.

Maintenance

Before proceeding with maintenance, set the power switch to the OFF position, and disconnect the power cord from the power outlet. Make absolutely sure that you grasp the power plug when disconnecting the power cord.

Use a soft cloth to clean the cabinet. To remove stubborn dirt, dilute some kitchen detergent, soak a rag in the solution, wring it out well, and use it to wipe away the dirt. Wipe up any remaining moisture using a dry cloth. Do not use paint thinners or benzine.

Specifications

[GENERAL]

Supply voltage: AC 120 V \pm 10%, 50 – 60 Hz Power consumption: 97 W DC supply voltage: 12 V DC power input current: 6.1 A

Ambient operating temperature:

41°F to 104°F (5°C to 40°C)

Ambient operating humidity:

10 to 85% (no condensation)

Weight:

18.04 lb (8.2 kg)

Dimensions (W×H×D):

8 7/16"×5 1/4"×16 15/16" (214×132×430 mm)

Recording format:

DVCPRO HD

Recording video signals:

1080i/59.94 Hz, 720p/59.94 Hz, selectable

Recording audio signals:

48 kHz, 16 bits, 8 channels

Recording tracks

- Digital video/audio: helical tracks
- Time code: helical tracks (sub-code area)
- Cue signal: 1 track
- Control (CTL): 1 track

Tape speed:

135.28 mm/sec

Recording time:

46 minutes (with AJ-HP46LP)

Tape used:

Metal tape

FF/REW time:

Less than 4 minutes (with AJ-HP46LP)

[VIDEO]

■ Digital video

Sampling frequency:

Y : 74.25/1.001 MHz

P_B/P_R : 37.125/1.001 MHz

Quantizing:

8 bits

Video compression system:

DCT + variable-length code

Video compression rate:

1/6.7

Error correction:

Reed Solomon product code

Video recording bit rate:

100 Mbps

■ Video input connectors

HD serial digital input:

BNC×1,

(compliant with SMPTE 292M/296M standard)

Reference input:

Automatic switching between analog composite and HD tri-level sync (59.94 Hz),

BNC×2 (loop-through), 75 Ω ON/OFF switchable

■ Video output connectors

HD serial digital outputs:

BNC×2

(compliant with SMPTE 292M/296M standard)

SD serial digital output (down-converter):

BNC×1

(compliant with SMPTE 259M-C standard)

Analog composite outputs (down-converter):

BNC×2, VIDEO 1, VIDEO 2 (superimposing ON/OFF)

■ Video output adjustment range

HD serial digital output system phase:

±0.5 H (±550 samples, 27 ns steps)

SD serial digital/composite video output system phase:

±0.5 H (±429 samples, 74 ns steps)

Composite video output SC phase:

±180°

Specifications

[AUDIO]

■ Digital audio

Sampling frequency:

48 kHz (synchronized with video)

Quantizing:

16 bits

Frequency response:

20 Hz to 20 kHz ± 1 dB (at reference level)

Dynamic range:

More than 85 dB

(1 kHz, emphasis OFF, "A" weighted)

Distortion:

Less than 0.1%

(1 kHz, emphasis OFF, reference level)

Crosstalk:

Less than -80 dB

(1 kHz, between two channels)

Wow & flutter:

Negligible

Headroom:

20 dB

■ Audio input connectors

Analog inputs (CH1, CH2, CH3, CH4):

XLR $\times 4$, 600 Ω /high impedance selectable

(default: high impedance),

+4/0/ -20 / -60 dBu selectable (-60 dBu: 3 k Ω)

HD serial digital input:

Compliant with SMPTE 299M standard

(BNC, 75 Ω)

■ Audio output connectors

Analog outputs (CH1, CH2, CH3, CH4):

XLR $\times 4$, low impedance,

+4/0/ -20 dBu selectable,

monitor output L/R selectable for CH3/CH4

output

HD serial digital output:

Compliant with SMPTE 299M standard

(BNC, 75 Ω)

SD serial digital output:

Compliant with SMPTE 272M-A standard

(BNC, 75 Ω)

Headphone output:

M3, 8 Ω , variable level

[OTHER INPUT/OUTPUT CONNECTORS]

Time code input:

BNC $\times 1$, 0.5 to 8 V [p-p], 10 k Ω

Time code output:

BNC $\times 1$, low impedance, 2.0 ± 0.5 V [p-p]

RS-422A input:

D-sub 9 pins, for AJ-A95, RS-422A interface

DC power output:

4-pin socket, DC 12 V, 250 mA, for AJ-A95

Weight and dimensions shown are approximate.
Specifications are subject to change without notice.

Panasonic

PANASONIC BROADCAST & TELEVISION SYSTEMS COMPANY
DIVISION OF MATSUSHITA ELECTRIC CORPORATION OF AMERICA

Executive Office:

3330 Cahuenga Blvd W., Los Angeles, CA 90068 (323) 436-3500

EASTERN ZONE:

One Panasonic Way 4E-7, Secaucus, NJ 07094 (201) 348-7621

Southeast Region:

1225 Northbrook Parkway, Ste 1-160, Suwanee, GA 30024 (770) 338-6835

Central Region:

1707 N Randall Road E1-C-1, Elgin, IL 60123 (847) 468-5200

WESTERN ZONE:

3330 Cahuenga Blvd W., Los Angeles, CA 90068 (323) 436-3500

Government Marketing Department:

52 West Gude Drive, Rockville, MD 20850 (301) 738-3840

Broadcast PARTS INFORMATION & ORDERING:

9:00 a.m. – 5:00 p.m. (EST) (800) 334-4881/24 Hr. Fax (800) 334-4880

Emergency after hour parts orders (800) 334-4881

TECHNICAL SUPPORT:

Emergency 24 Hour Service (800) 222-0741

Panasonic Canada Inc.

5770 Ambler Drive, Mississauga, Ontario L4W 2T3 (905) 624-5010

Panasonic de Mexico S.A. de C.V.

Av angel Urraza Num. 1209 Col. de Valle 03100 Mexico, D.F. (52) 1 951 2127

Panasonic Sales Company

Division of Matsushita Electric of Puerto Rico Inc.

San Gabriel Industrial Park, 65th Infantry Ave., Km. 9.5, Carolina, Puerto Rico 00630 (787) 750-4300

